

| Product code | Color |
|--------------|-----------------|
| 149401 | Stainless steel |

General Specifications

| | |
|-----------------------|---|
| Product type | : Outdoor recessed |
| Mounting type | : Ground - recessed |
| Description | : Recessed upright, flush with the ground, suitable for vehicles and pedestrian traffic, it is designed with materials that preserve them from the aggression of oxidizing agents. The optics are symmetrical, adjustable +/- 7°. A range of professional optics are available as accessories, to get different beam angles. Recessed housing included in the fittings. IP67. |
| Indoor/outdoor lights | : Outdoor |
| Applications | : Architectural and natural settings, Façades of buildings, Gardens, Monuments |

Lighting specifications

| | |
|----------------------------------|------------------------------|
| Lamp description | : LED 1800lm 12W 3000K CRI85 |
| Nominal lumens on thermal regime | : 1800 |
| Efficiency L.O.R. (%) | : 85,0 |
| Delivered lumens (lm) | : 1530 |
| Lamp wattage (W) | : 12 |
| Color temperature (K) | : 3000 |
| Average lamp life (h) | : L80B10 50.000 |
| Photobiological risk group | : RG1 |

Physical Specifications

| | |
|----------------------|---|
| Body | : Housing and recessed housing in high-resistant thermoplastic material |
| Reflector | : Mirror metallized technopolymer |
| Closing Screen | : Tempered glass |
| Frame | : Stainless steel |
| Gaskets | : Silicone |
| Mechanical load (Kg) | : 2000 |
| Screws | : Stainless steel |

Electrical Specifications

| | |
|-----------------|--|
| Dimmable | : Dimmable on the mains |
| Glow wire (°C) | : 850 |
| Driver | : Included |
| Driver mounting | : Integrated |
| Cable gland | : Nickel-plated brass cable gland M12x1, 5 |
| Voltage (V) | : 230/240 |
| Frequency (Hz) | : 50/60 |

Weight and Dimensions

| | |
|------------------------|---------|
| Shape | : Round |
| External diameter (mm) | : 190 |
| Height (mm) | : 275 |
| Cutout shape | : Round |
| Recessed depth (mm) | : 295 |
| Weight (Kg) | : 2.9 |

Optical Specifications

| | |
|----------------------|--|
| Aiming | : Adjustable |
| Light distribution | : Symmetric |
| Light emission | : Direct |
| Light beam | : 26° |
| Temperature max (°C) | : 40 |
| Note | : 15°, 45° (mirror metallized) optics are available on demand. |

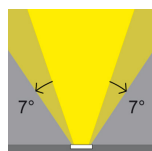
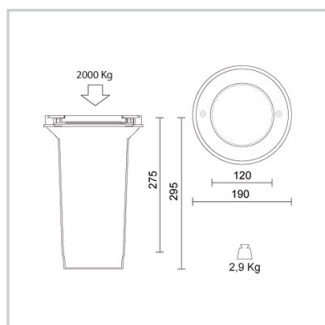

ACCESSORIES



Product Code : 160821
Name : 10mt Supply cable coil, H05RN-F 2x1 mm²



Product Code : 28-9001-51
Name : Professional optica device 15°
Finish : Mirror metallized
Beam : 15°
Shape : Round



Product Code : N/S
Name : Professional optic device 26°
Finish : Mirror metallized
Beam : 26°
Shape : Round



Product Code : N/S
Name : Professional optic device 45°
Finish : Mirror metallized
Beam : 45°
Shape : Round

| Lamps | Lamp categories | Lamp type | Lamp wattage (W) | Nominal lumens on thermal regime (lm) | Color temperature (K) | Color rendering |
|--|-----------------|-----------|------------------|---------------------------------------|-----------------------|-----------------|
|  | LED | COB LED | 12 | 1800 | 3000 | 85 |

Photometrics

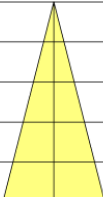
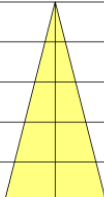
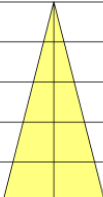
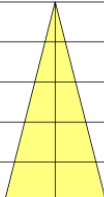
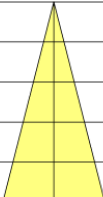
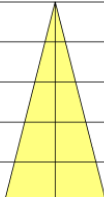
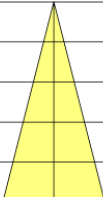
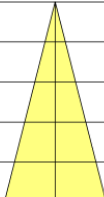
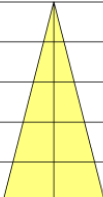
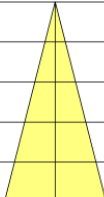
| 149401 Gamma Angles 180° 120° 90° 75° 60° 45° 30° 15° 0° 15° 30° cd/klm | ACHILLE190 LED 12W 1800 lm | | | | R:100% | | | | I.Max:2589 Cd/Klm | | | | | |
|--|----------------------------|------|---------|---------|---|------|------|---------|-------------------|--|------|------|---------|---------|
| | H[m] | D[m] | Max lux | Med lux | Alpha=28° | H[m] | D[m] | Max lux | Med lux | Beta=28° | H[m] | D[m] | Max lux | Med lux |
| | 1.00 | 0.51 | 3969 | 2385 |  | 1.00 | 0.51 | 3969 | 2385 |  | 1.00 | 0.51 | 3969 | 2385 |
| | 2.00 | 1.02 | 992 | 596 |  | 2.00 | 1.02 | 992 | 596 |  | 2.00 | 1.02 | 992 | 596 |
| | 3.00 | 1.53 | 441 | 265 |  | 3.00 | 1.53 | 441 | 265 |  | 3.00 | 1.53 | 441 | 265 |
| | 4.00 | 2.04 | 248 | 149 |  | 4.00 | 2.04 | 248 | 149 |  | 4.00 | 2.04 | 248 | 149 |
| | 5.00 | 2.55 | 159 | 95 |  | 5.00 | 2.55 | 159 | 95 |  | 5.00 | 2.55 | 159 | 95 |

Pictures and Applications

